



Mensch und Maschine Software SE

Company Presentation

Status March 16, 2020 / Annual report 2019



Business model

- Leading vendor of CAD/CAM/CAE/PDM/BIM solutions
 - ◆ CAD/CAM/CAE = Computer Aided Design / Manufacturing / Engineering
PDM = Product Data Management / BIM = Building Information Management
 - ◆ Founded 1984 – 36 years on market // IPO 1997 – 23 years public
- Business model with two Segments
 - ◆ M+M Software: Proprietary Standard Software
~70% CAD/CAM // ~30% BIM/Garden/Landscaping/CAE
 - ◆ VAR Business: Technical Digitalisation Solutions
~60% Customer specific projects / ~40% Training

Benefit VAR Business:
Sales / Market share

Benefit Software:
Very profitable

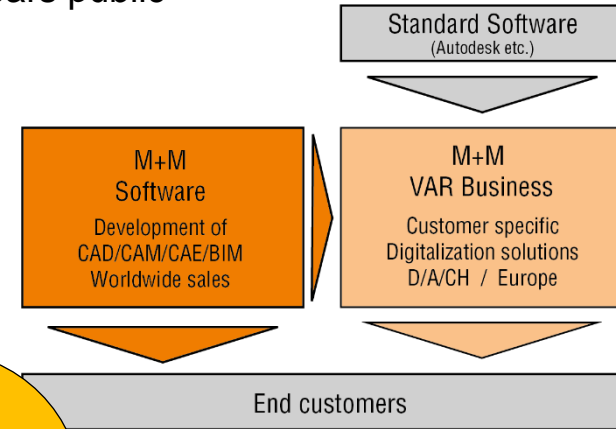
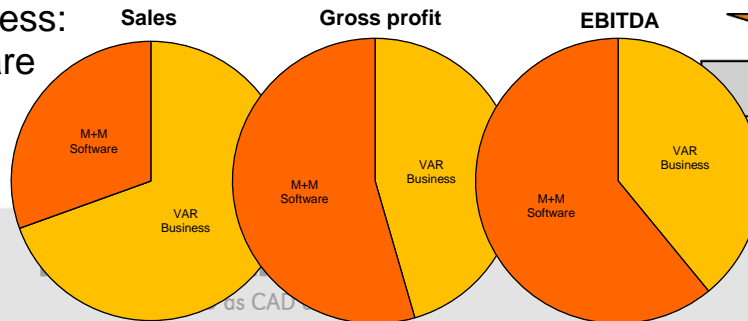

Business model

■ Geographical sales contribution: (2019)

- ◆ Germany: EUR ~112mln / ~46%
- ◆ Austria/Switzerland: EUR ~51 mln / ~21%
- ◆ Europe (other): EUR ~62 mln / ~25%
France / Italy / UK / Poland / Romania / Iberia / other
- ◆ Asia/America: EUR ~20 mln / ~8%
Japan / China / India / APAC / USA / Brazil / other
(M+M's own CAM and BIM Software only)

■ Headcount: (Full time equivalent 2019)

- ◆ 946 (PY: 821 / +15% or +4.5% organic)
 - 485 / 51% (PY: 364 / 44%) M+M Software
 - 461 / 49% (PY: 457 / 56%) VAR Business
- ◆ Gross headcount at Dec 31, 2019: 1,004

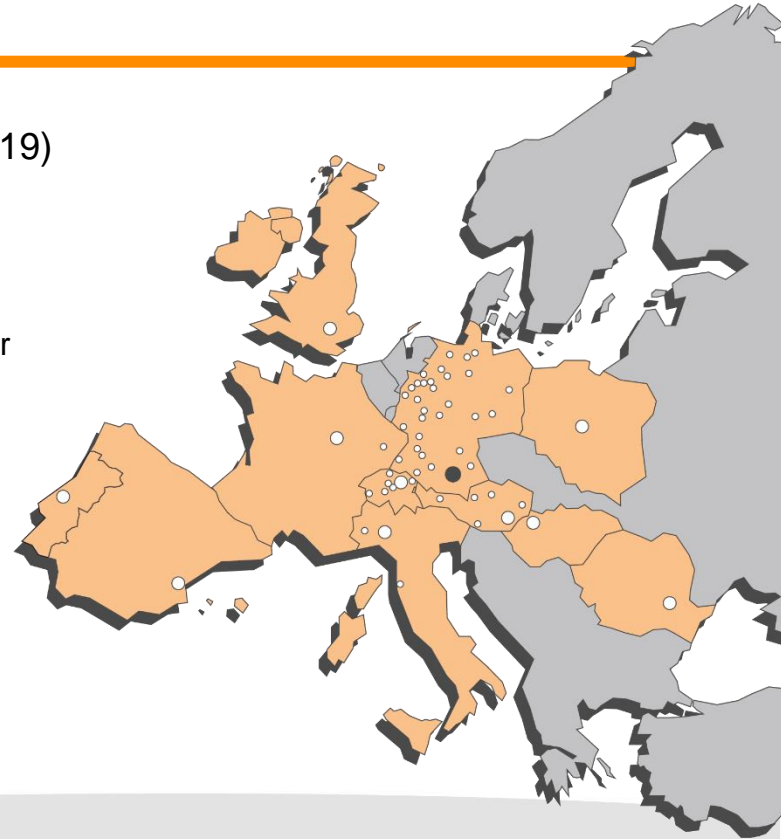
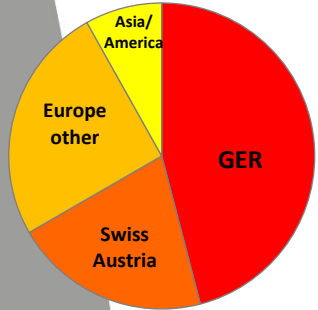

Business model

■ Broad industry balance:

- ~2/3 Industry: e.g. Mechanical/Electrical/Process Engineering, Tool/Mold/Die Making, Automotive/Aerospace/Shipbuilding, Hydraulics, Pneumatics, Industrial design
- ~1/3 BIM: e.g. Architecture, Building Services, Structural/Civil Engineering, Bridge and Tunnel Construction, Infrastructure, Facility Management, Gardening/Landscaping
- Interdisciplinary: e.g. Digital Factory, PDM/PLM, Simulation, Plant Design, Visualization/Animation

◆ Extensive installed base:

>100,000 active seats @ more than 30,000 customers

◆ Wide price/performance range:

- Software from <1,000 Euro to >100,000 Euro per seat
- Pure B2B Business, only professionals, no consumers

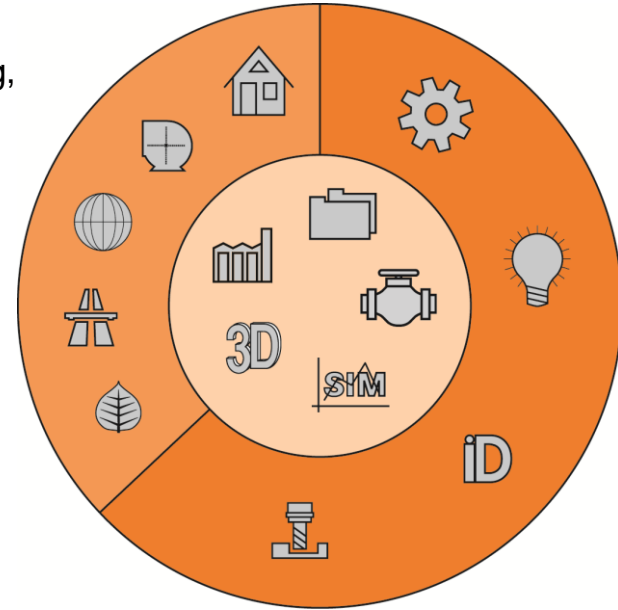

CAD/CAM in practice (M+M Software)

■ CAE – Computer Aided Engineering

- Yet: ecs cad – until 2008 M+M Software, end of 2008 sold to Autodesk, since 2014 licensed back and developed / supported by M+M
- Newly developed: eXs – fully data- and largely user interface compatible
 - High performance database, more functionality, simpler usability, free configurability
 - For Industry disciplines electrical and process engineering, hydraulics and pneumatics
 - As well as for all building services disciplines in BIM projects
 - For ecs cad maintenance customers free automatic license transition

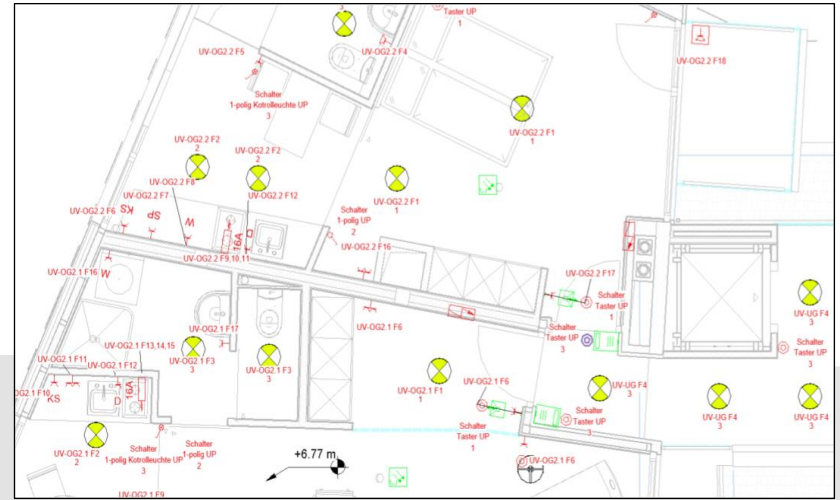
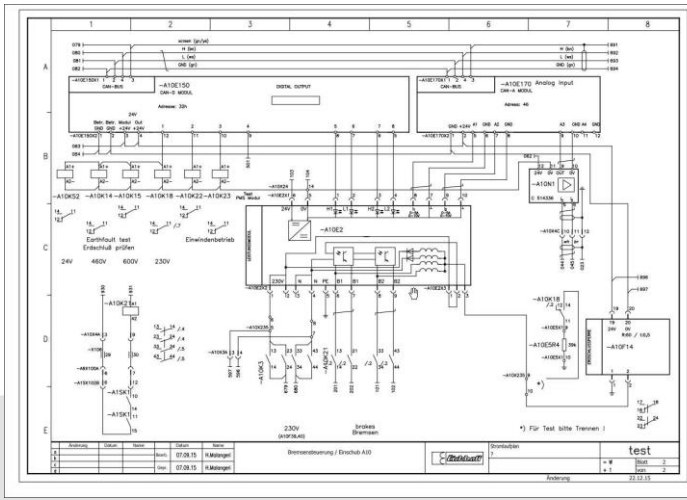

CAD/CAM in practice (M+M Software)

- Gardening / Landscaping / Earthworks for Architects and Implementers
 - M+M Subsidiary DATAflor, Goettingen, Germany
 - Integrated software solutions not only containing graphical planning but also calculation, tender, quoting, construction site controlling and billing
 - Two examples from the extensive functionality:
 - Digital terrain model: Comfortable three dimensional landscape design (middle picture)
 - GRUENSTUDIO 3D: Live experiencing the future garden via VR glasses (right picture)

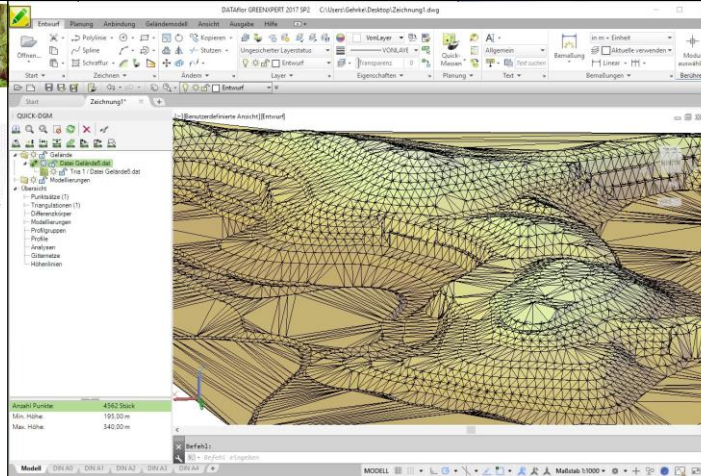

CAD/CAM in practice (M+M Software)

- New in 2019: BIM, Structural Analysis and Reinforcement
 - Strategic shareholding in SOFiSTiK AG increased from 13.3% to 51%
 - Share swap, Founders/Management staying on board with 49% shareholding
 - SOFiSTiK (est. 1987) is a technology leader in bridge, tunnel and building construction
 - In more than 30 years, thousands of construction projects have been realised and calculated with SOFiSTiK software, e.g. BMW-Welt Munich, new Bosphorus bridge, Brasilia National Stadium...

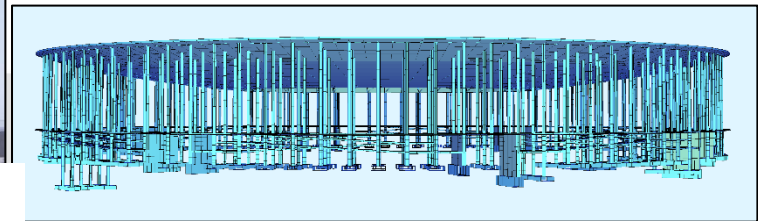
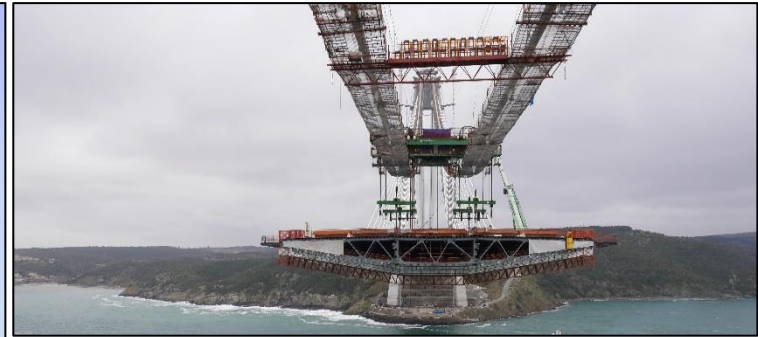

www.sofistik.com/company/references

CAD/CAM in practice (M+M Software)



CAD/CAM in practice (M+M Software)

- CAM – Computer Aided Manufacturing
 - Subsidiary Open Mind – Product line hyperMILL
 - High end: Average revenue approx. EUR 30,000 per seat
 - **CAM is contributing ~40% of group gross margin**

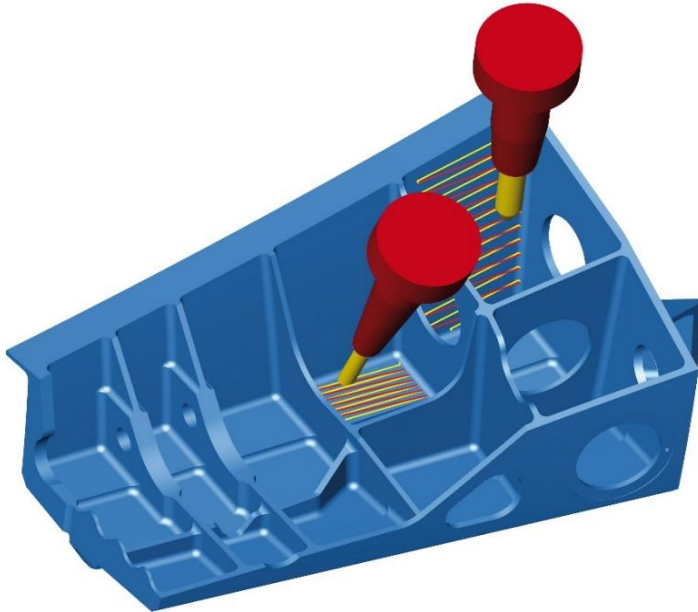

Precision machine tools' purchase prices are in the six or seven digit Euro range. hyperMILL reduces milling times by up to 90% through intelligent machining strategies, pushing return on investment for these expensive machine tools to completely new dimensions.



 **OPEN MIND**
THE CAM FORCE

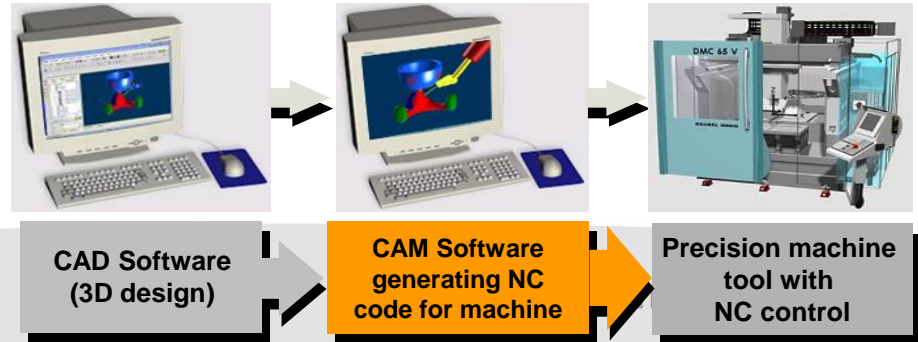

CAD/CAM in practice (M+M Software)

Up to 5x faster material removal by 'helical' roughing.

Flat surface finishing up to 10x faster by using special conical cutters with slightly convex curvature.

Milling time for this lightweight aerospace part:
2h05min instead of 10h30min => 80% productivity gain.

Total 80% productivity gain: 2h05 instead of 10h30

78% faster roughing + 90% faster flat surface finishing:

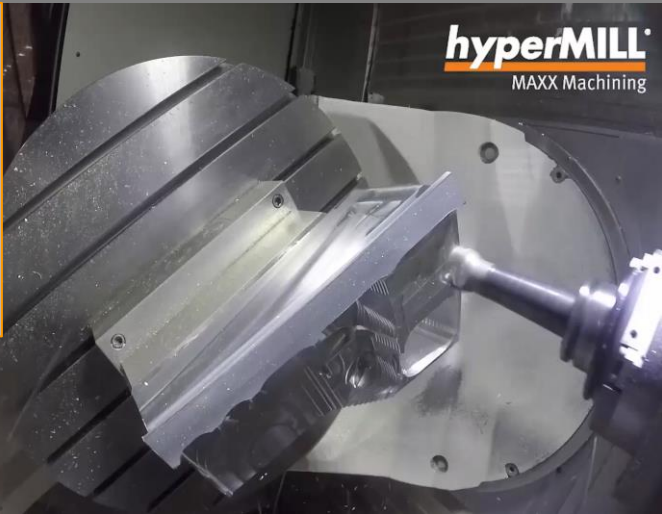
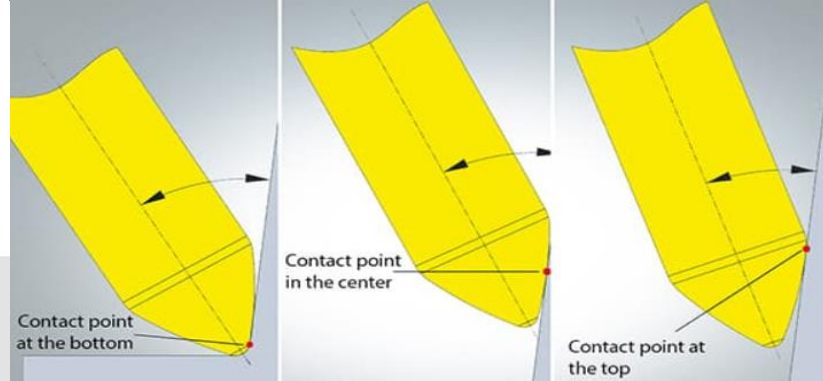
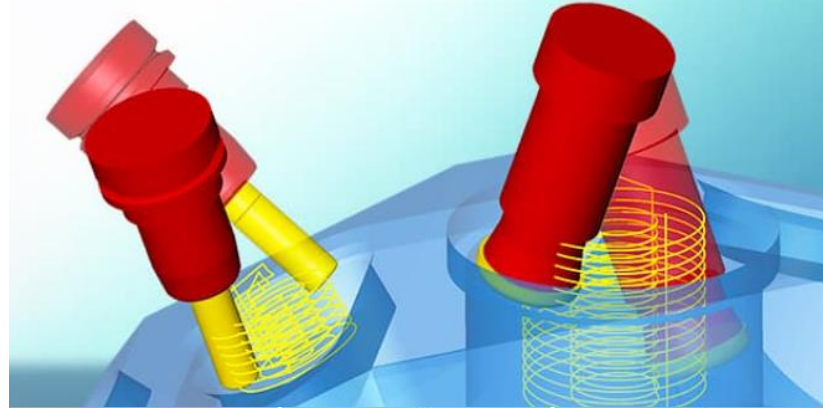

CAD/CAM in practice (M+M Software)

CAM (subtractive) meets 3D printing (additive):

New hybrid machine tools with an LMD device (Laser Metal Deposition) combine the advantages of 3D metal printing (building parts from scratch) and 5-axis milling (finishing defined surfaces with high accuracy) without re-clamping. hyperMILL now supports this process holistically. Example: Hybrid repair of a turbine blade.

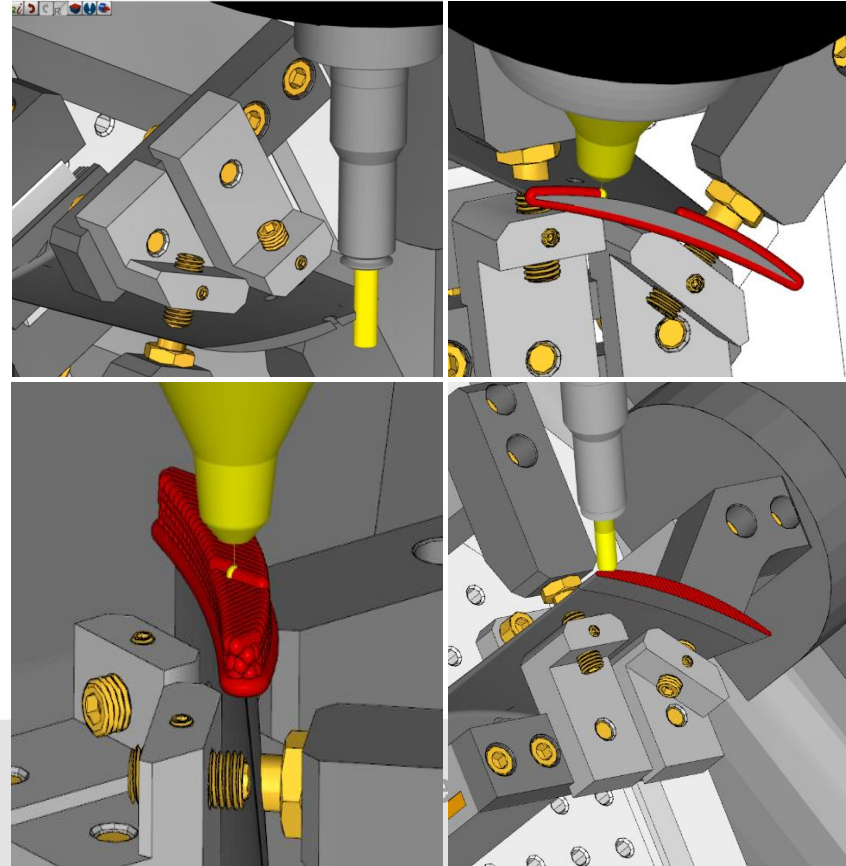
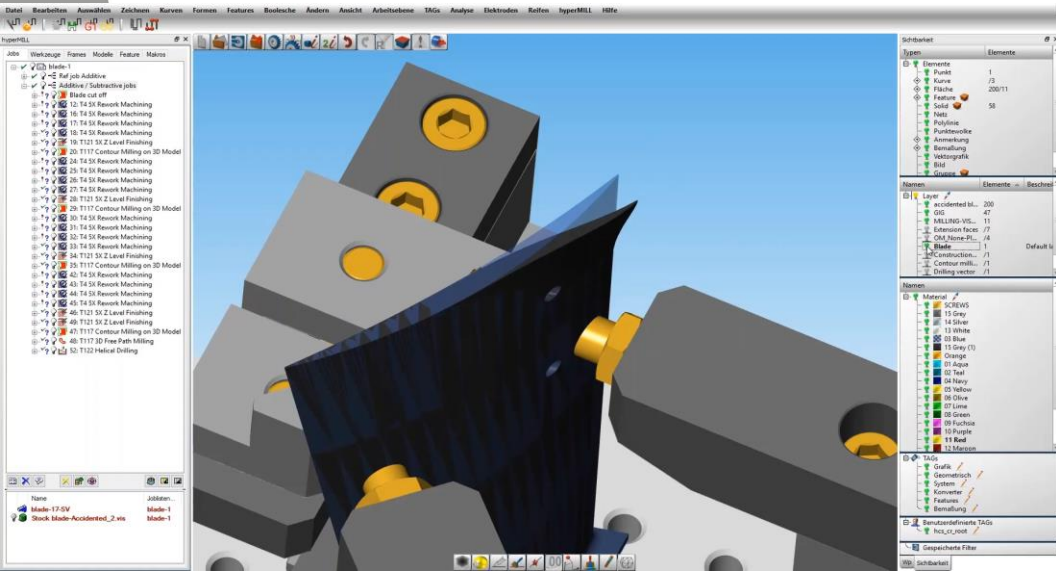

Some CAM Key Customers



CAD/CAM in practice (VAR Business)

- Example BIM – Building Information Modelling / Management: Digital Building Manual for Facility Management

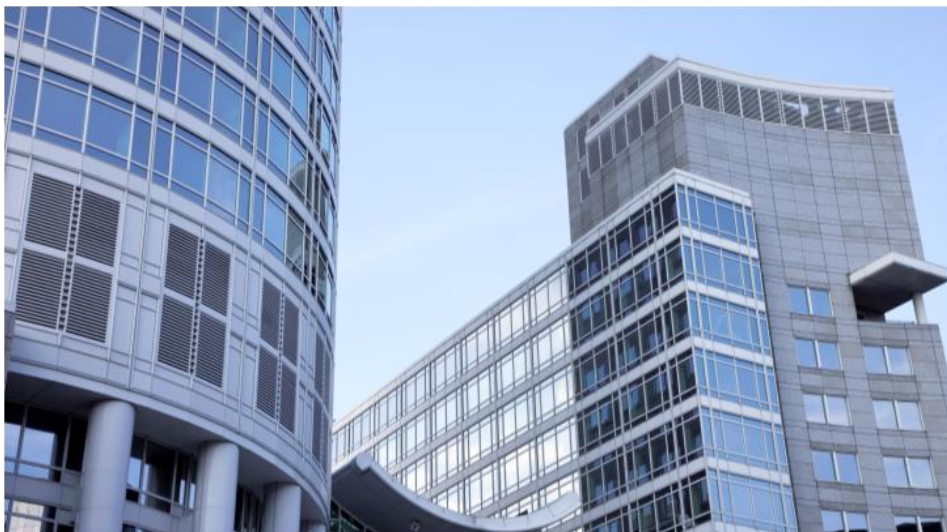

bim  booster bin  ready



CAD/CAM in practice (VAR Business)

- Example: Infrastructure/BIM – Steel plant becoming ‘Digital Factory’
Large project since 2010 including over a dozen modules totally representing several man-years. Here: GPS aided locomotive tracking on the factory premises



Customer: HKM Hüttenwerke Krupp Mannesmann, Duisburg-Huckingen, Germany

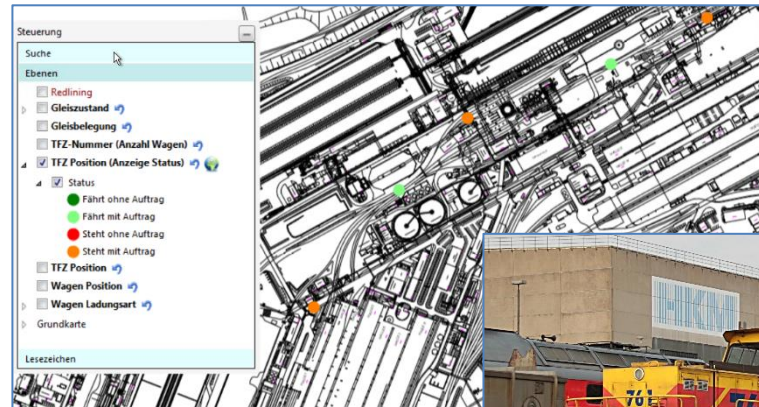

mapedit

CAD/CAM in practice (VAR Business)

- Example: Data Management for a train operator
Integrated system for design, data management and Office

Customer: BLS Bern-Loetschberg-Simplon Bahn AG,
Bern, Switzerland

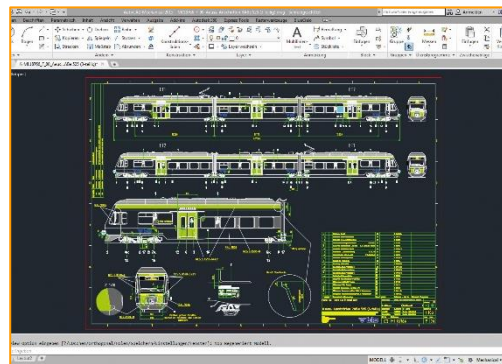

ecs cad



man machine
CAD as CAD can

mensch machine
CAD as CAD can

CAD/CAM in practice (VAR Business)

- Example: Industry 4.0 meets BIM
BIM compatible catalog data for large kitchen planning

Customer: Rational AG, Landsberg, Germany



CAD/CAM in practice (VAR Business)

- Fully automated variant design with customX - for >90% productivity gain
Project examples: Electric distribution boxes and Diesel filters

Customer: Bals Elektrotechnik, Kirchhundem, Germany



Customer:
Willibrord Lösung
Filtertechnik,
Hattingen, Germany

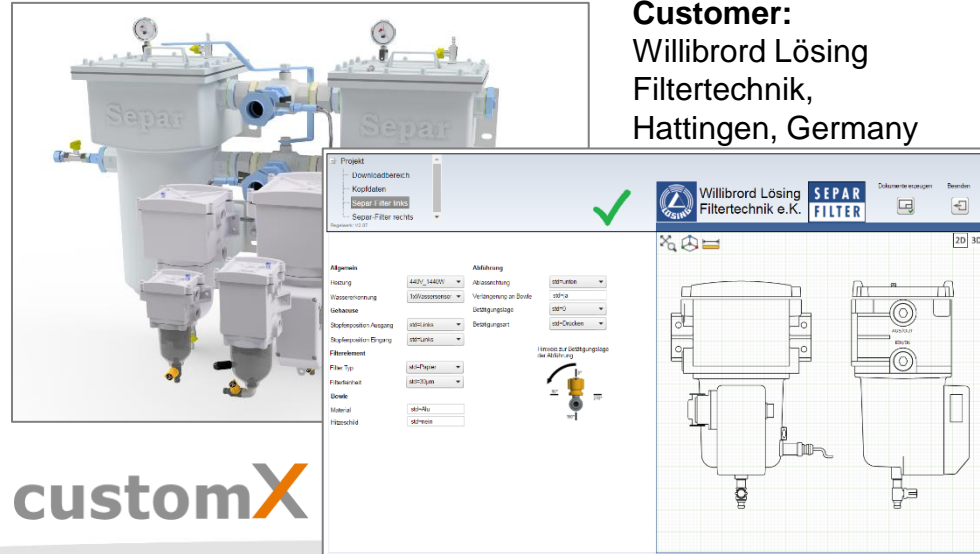

customX



Some VAR Business Key Customers



Sales & gross profit

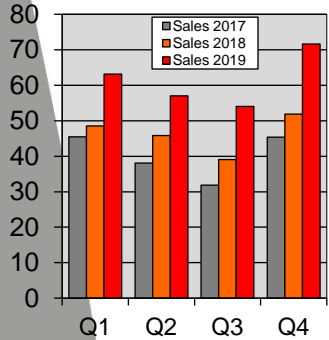

- Record sales 2019: EUR 245.94 mln / +33% (organic +25%)
 - ◆ M+M Software: EUR 75.08 mln / +35% (organic +9%)
 - ◆ Solid organic growth plus SOFiSTiK acquisition
 - ◆ VAR Business: EUR 170.86 mln / +32%
 - ◆ Strong growth – counter-reaction to the temporary retarding effect of Autodesk’s sales to subscription transition in 2016/17
 - ◆ Typical seasonality: Q1/Q4 strong / calmer mid of year
Q1: +30% / Q2: +24% / Q3: +38% / Q4: +38%

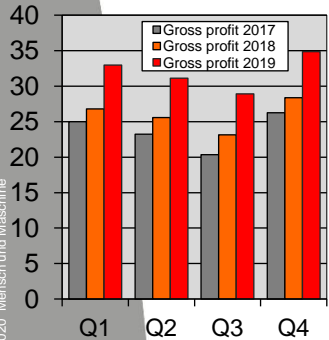

- Record gross profit: EUR 127.89 mln / +23% (organic +13%)
 - ◆ M+M Software: EUR 69.70 mln / +28% (organic +9%)
 - ◆ VAR Business: EUR 58.19 mln / +17%
 - ◆ Gross profit seasonality smoother than for sales
Q1: +23% / Q2: +22% / Q3: +25% / Q4: +23%
- 2019 growth was significantly above expectations
 - ◆ Non-recurring effects e.g. by Autodesk incentives for 3YR contracts

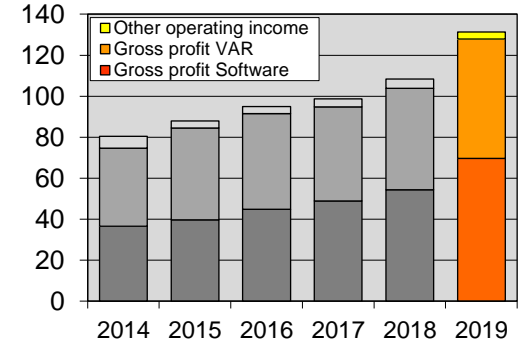
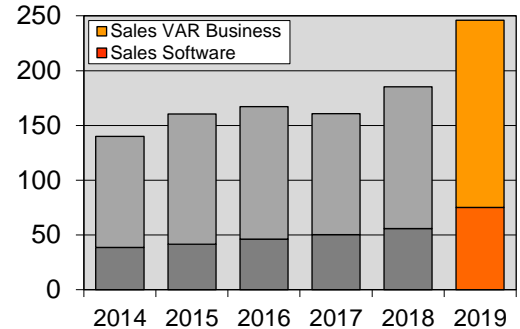

Earnings / cashflow / dividend

- Record EBITDA 2019: EUR 36.55 mln (PY: 22.75)
 - ◆ EBITDA group yield: 14.9% (PY: 12.3%)
 - ◆ Attention: IFRS16 (Shifting leasing expenses to depreciation) distorting PY comparison
 - ◆ M+M Software: EUR 22.27 mln (PY: 14.68) / yield 29.7% (PY: 26.3%)
 - ◆ VAR Business: EUR 14.28 mln (PY: 8.07) / yield 8.4% (PY: 6.2%)
- ◆ Record EBIT 2019: EUR 27.19 mln (PY: 19.66 / +38%) (organic +25%)
 - ◆ M+M Software: EUR 17.37 mln (PY: 13.21 / +32%) (organic +12%)
 - ◆ VAR Business: EUR 9.82 mln (PY: 6.45 / +52%)
 - ◆ Seasonality Q1: +39% / Q2: +32% / Q3: +54% / Q4: +36%
- ◆ Record net profit 2019: EUR 16.67 mln (PY: 11.69 / +43%) (organic +35%)
 - ◆ Per share: 99 Cents (PY: 71.5)
- ◆ Record operating cashflow 2019: EUR 26.35 mln (PY: 15.23 / +73%)
 - ◆ Per share: 157 Cents (PY: 93)
 - ◆ Growth adjusted by IFRS16 effects: +36%
- ◆ Dividend proposal 2019: 85 Cents (PY: 65 / +31%)

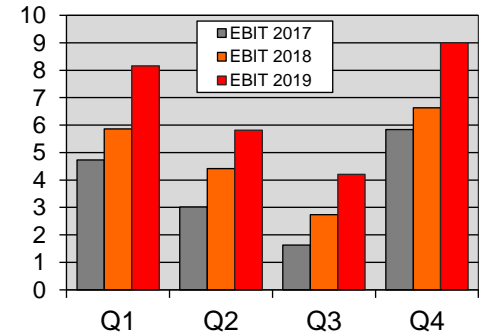
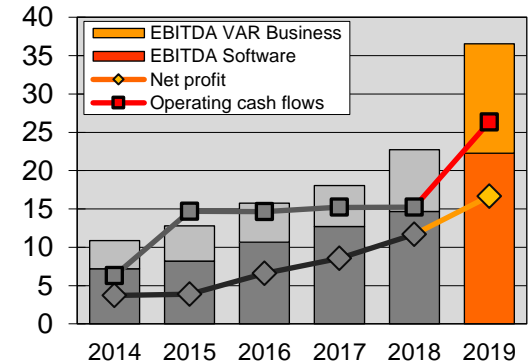

Review & Outlook

Review on profitable growth:

- Gross profit 2014-2019: EUR +53.2 mln / +71%
 - ✓ EUR +10.6 mln / +11% average gross profit growth p.a.
- EBITDA 2014-2019: EUR +25.6 mln / +235%
 - ✓ EUR +5.1 mln / +27% average EBITDA growth p.a.
- Gain 48%: 1 EUR more gross profit >> 48 Cents more EBITDA
 - ✓ Profit optimized growth through effective cost control management

Clear target: Continuing sustainable profitable growth

- 2020E: Organic growth + margin potential = economy of scale
 - ◆ Sales +10-12% to EUR 270-275 mln / Gross profit +10-12% to EUR 140-143 mln (Growth H1 before end of Autodesk Maintenance to Subscription significantly stronger than H2)
 - ◆ EBITDA +13-18% to EUR 41-43 mln
 - ◆ EPS +18-24 Cents to 117-123 Cents / Dividend +15-20 Cents to 100-105 Cents
- 2021E: Sales / Gross profit +10-12% / EBITDA +13-18%
 - ◆ EPS +18-24 Cents / Dividend +15-20 Cents

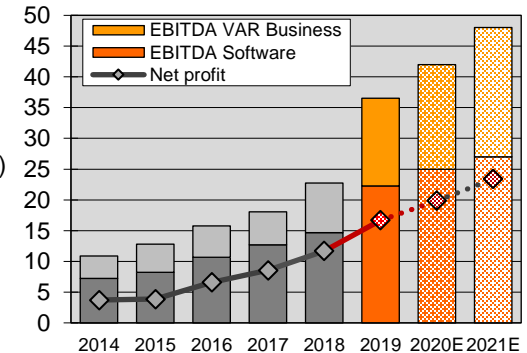
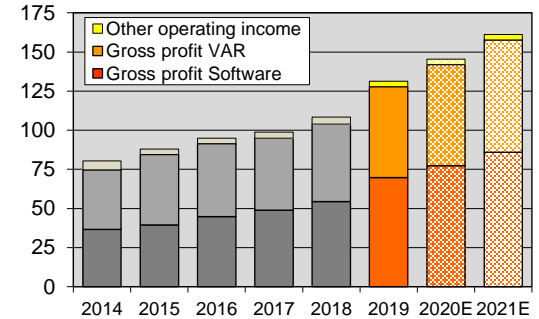

The M+M share

Listings:

- ◆ scale, Frankfurt (scale30)
- ◆ m:access, Munich

Designated Sponsors:

- ◆ LBBW, Stuttgart
- ◆ Oddo Seydler, Frankfurt

Analyst Coverage:

- ◆ LBBW: „Buy“ – fair value EUR 50.25
- ◆ SMC Research*: „Hold“ – fair value EUR 50.50
- ◆ EDISON*: **scale** research report – no price tag

*available in English language

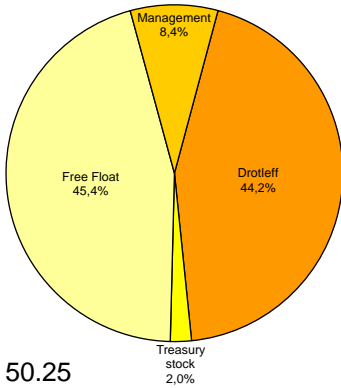

M+M is both a public and private company

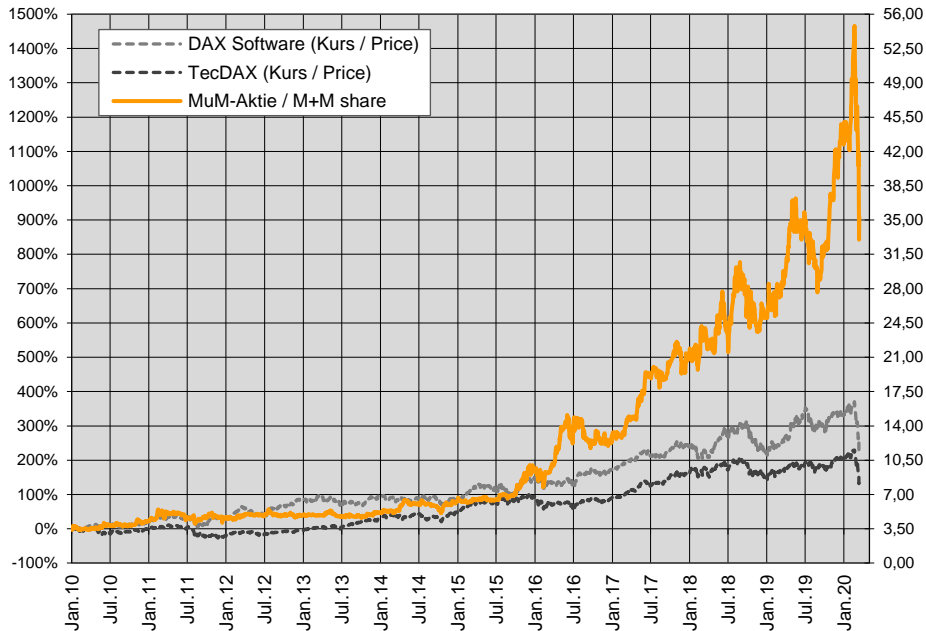

Total dividends paid since 2010: EUR 2.65

Why invest in M+M ?

- M+M is a leading vendor of technical software solutions
 - ◆ Founded 1984 – 36 years of established market position
 - ◆ More than 30,000 active customers worldwide
 - ◆ Private and 23 years public company
- Sustainable profitable growth / highly scalable business model
 - ◆ Organic growth (CAGR): long-term average approx. 10% p.a.
 - ◆ EBITDA yield 2019 was 14.9% - mid-term potential >18%
 - ◆ 18-24 Cents p.a. EPS growth target secured by effective cost management
- Good dividend return due to high pay-out ratio
 - ◆ Low CAPEX, as the lion's share of software development is not capitalized
 - ◆ Founder/CEO Adi Drotleff swapping the majority of his dividend rights to shares every year





Thank you for your attention!

For more Information: www.mum.de / Investor Relations

